

BTB80 Serial Standard TRIACS

GENERAL DESCRIPTION:

High current density due to double mesa technology; Glass Passivation. BTB80 series TRIACS is suitable for general purpose AC switching. They can be used as an ON/OFF Function in applications such as static relays, heating regulation, induction motor starting circuits..or for phase control operation light dimmers, motor speed controllers, etc.

Main Features:

$I_{T(RMS)}$	V_{DRM}/V_{RRM}	V_{TM}
80 A	600V 800V 1200V 1600 V	$\leq 1.55V$

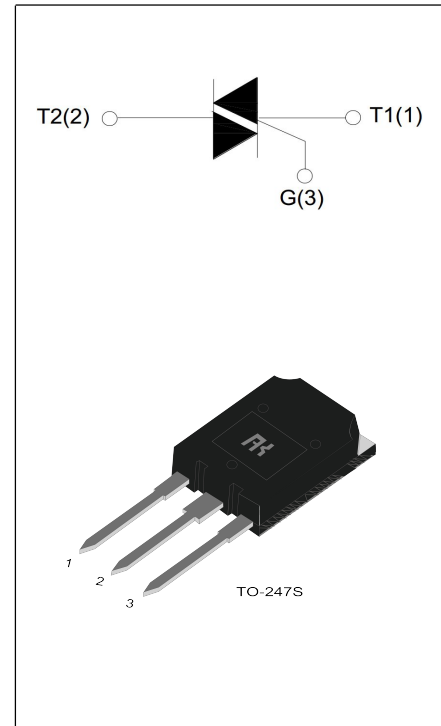

Absolute Ratings(limiting values) :

Symbol	Parameter		Value	Unit
T_{stg}	Storage junction temperature range		- 40 to + 150	°C
T_j	Operating junction temperature range		- 40 to + 125	°C
$I_{T(RMS)}$	RMS on-state current	TO-247S (TC=70°C)	80	A
I_{TSM}	Non repetitive surge peak on-state current (tp=10ms)		800	A
V_{DRM}	Repetitive peak off-state voltage(Tj =25°C)		600/800/1200/1600	V
V_{RRM}	Repetitive peak reverse voltage(Tj =25°C)		600/800/1200/1600	V
V_{DSM}	Non repetitive surge peak Off-state voltage		$V_{DRM} + 100$	V
V_{RSM}	Non repetitive peak reverse voltage		$V_{RRM} + 100$	V
I^2t	I^2t value for fusing tp = 10 ms		3200	A ² s
dI/dt	Critical rate of rise of on-state current ($I_G = 2 \times I_{GT}$)		100	A/ μ s

I_{GM}	Peak gate current	8	A
P_{G(AV)}	Average gate power dissipation	2	W
P_{GM}	Peak gate power	10	W

Electrical Characteristics : (T_j=25°C unless otherwise specified)

Symbol	Test Condition	Quadrant	Range	Value	Unit
I_{GT}	V _D =12V R _L =33Ω	I-II-III	MAX	50	mA
V_{GT}		I-II-III	MAX	1.3	V
V_{GD}	V _D =V _{DRM} R _L =3.3kΩ T _j =125°C	I-II-III	MIN	0.2	V
I_L	I _G =1.2 I _{GT}	I-III	MAX	80	mA
		II		120	
I_H	I _{TM} = 100mA		MAX	60	mA
dV/dt	V _D =2/3V _{DRM} Gate Open T _j =125°C		MIN	1000	V/μs
(dV/dt)_c	Without snubber T _j =125°C		MIN	20	V/μs

Static Characteristics

Symbol	Parameter		Value(MAX)	Unit
V_{TM}	I _{TM} =120A tp= 380μs	T _j =25°C	1.55	V
I_{DRM} I_{RRM}	V _D =V _{DRM} , V _R =V _{RRM}	T _j =25°C	50	μ A
		T _j =125°C	10	mA

Thermal Resistances :

Symbol	Parameter		Value	Unit
R_{th(j-c)}	Junction to case for AC	TO-247S	0.38	°C/W

Fig.1: Maximum power dissipation versus RMS on-state current

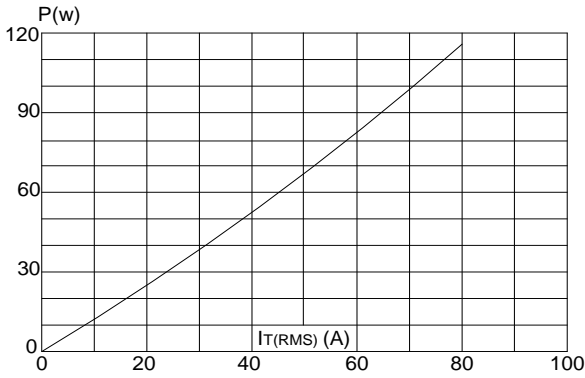

Fig.2 : RMS on-state current versus case temperature

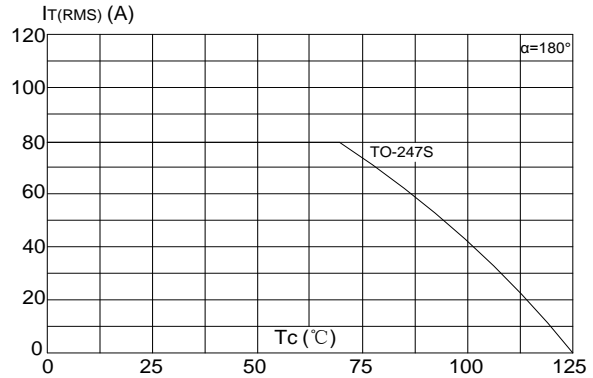

Fig.3 : Surge peak on-state current versus number of cycles

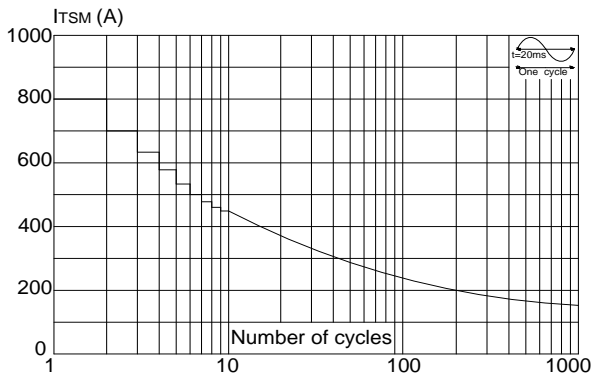

Fig.4 : On-state characteristics (maximum values)

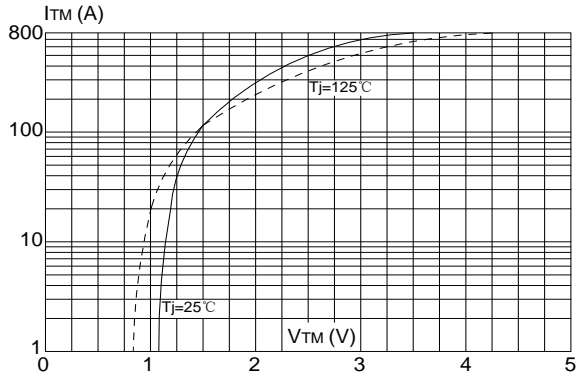

Fig.5 : Non-repetitive surge peak on-state current for a sinusoidal pulse with width $t_p < 20\text{ms}$ and corresponding value of $I t$ ($dI/dt < 100\text{A}/\mu\text{s}$)

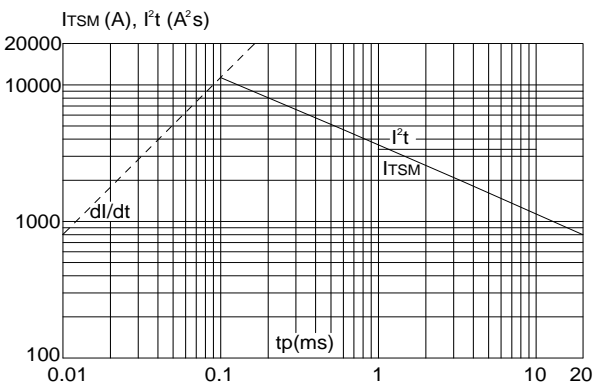
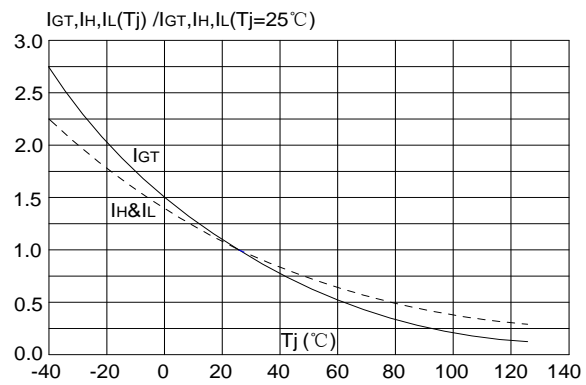
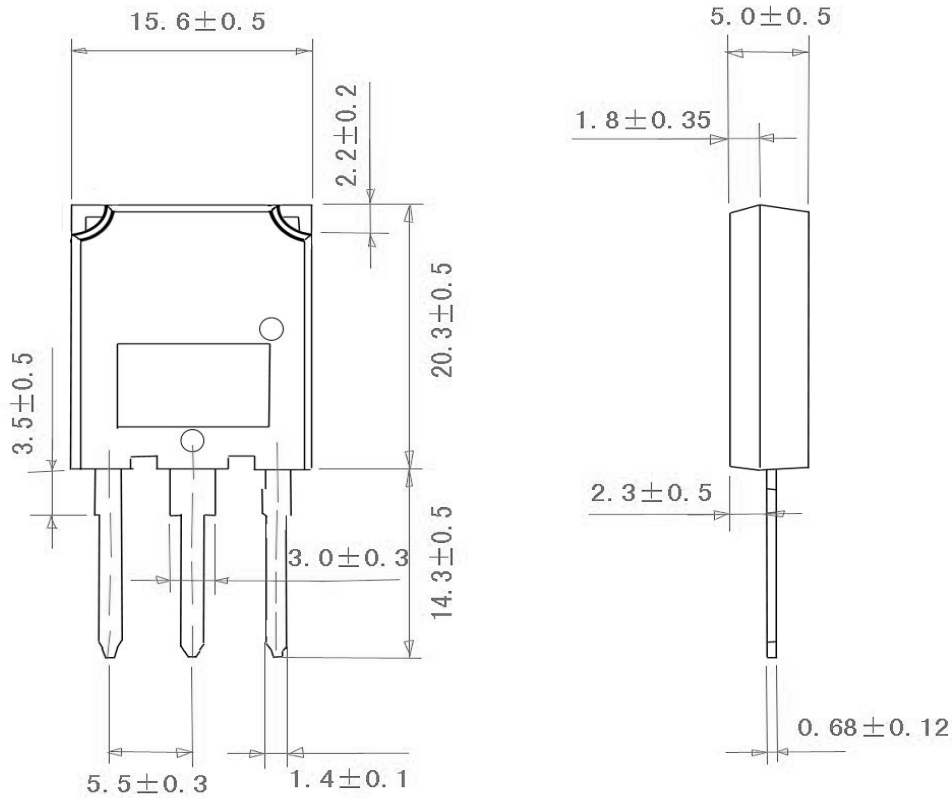

Fig.6: Relative variations of gate trigger current, holding current and latching current versus junction temperature



Package Mechanical Data :



Ordering Information:

