

BTB41 Serial Standard TRIACS

GENERAL DESCRIPTION:

High current density due to double mesa technology; Glass Passivation. BTB41 series TRIACS are suitable for general purpose AC switching. They can be used as an ON/OFF Function in applications such as static relays, heating regulation, induction motor starting circuits..or for phase control operation light dimmers, motor speed controllers, etc.

Main Features:

$I_{T(RMS)}$	V_{DRM}/V_{RRM}	V_{TM}
40 A	600/800/1200/1600 V	≤ 1.5 V

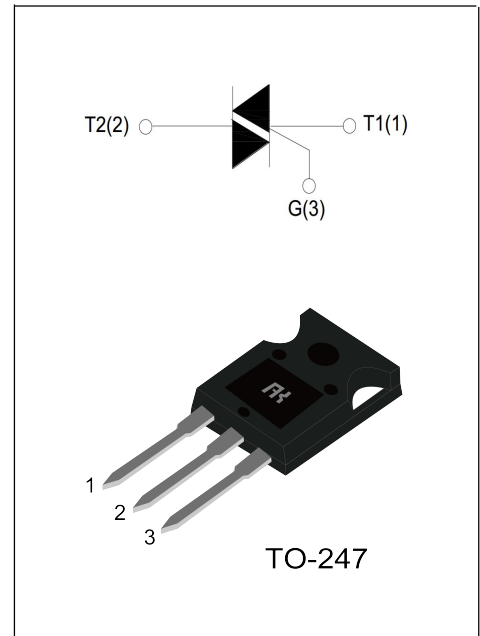

Absolute Ratings(limiting values) :

Symbol	Parameter		Value	Unit
T_{stg}	Storage junction temperature range		- 40 to + 150	$^{\circ}C$
T_j	Operating junction temperature range		- 40 to + 125	$^{\circ}C$
$I_{T(RMS)}$	RMS on-state current	TO-247(Non-Ins) (TC=90 $^{\circ}C$)	40	A
I_{TSM}	Non repetitive surge peak on-state current (tp=10ms)		400	A
V_{DRM}	Repetitive peak off-state voltage(Tj =25 $^{\circ}C$)		600/800/1200/1600	V
V_{RRM}	Repetitive peak reverse voltage(Tj =25 $^{\circ}C$)		600/800/1200/1600	V
V_{DSM}	Non repetitive surge peak Off-state voltage		$V_{DRM} + 100$	V
V_{RSM}	Non repetitive peak reverse voltage		$V_{RRM} + 100$	V
I^2t	I^2t value for fusing tp = 10 ms		880	A 2s
dI/dt	Critical rate of rise of on-state current ($I_G = 2 \times I_{GT}$)		50	A/ μs

I_{GM}	Peak gate current	4	A
P_{G(AV)}	Average gate power dissipation	1	W
P_{GM}	Peak gate power	10	W

Electrical Characteristics : (T_j=25°C unless otherwise specified)

Symbol	Test Condition	Quadrant	Range	Value	Unit
I_{GT}	V _D =12V R _L =33Ω	I-II-III	MAX	50	mA
V_{GT}		I-II-III	MAX	1.3	V
V_{GD}	V _D =V _{DRM} R _L =3.3kΩ T _j =125°C	I-II-III	MIN	0.2	V
I_L	I _G =1.2 I _{GT}	I-III	MAX	80	mA
		II		100	
I_H	I _{TM} = 100mA		MAX	60	mA
dV/dt	V _D =2/3V _{DRM} Gate Open T _j =125°C		MIN	1000	V/μs
(dV/dt)_c	Without snubber T _j =125°C		MIN	20	V/μs

Static Characteristics

Symbol	Parameter		Value(MAX)	Unit
V_{TM}	I _{TM} =60A tp= 380μs	T _j =25°C	1.55	V
I_{DRM} I_{RRM}	V _D =V _{DRM} , V _R =V _{R_{RRM}}	T _j =25°C	10	μ A
		T _j =125°C	5	mA

Thermal Resistances :

Symbol	Parameter		Value	Unit
R_{th(j-c)}	Junction to case for AC	TO-247(Non-Ins)	0.8	°C/W

FIG.1 Maximum power dissipation versus RMS on-state current

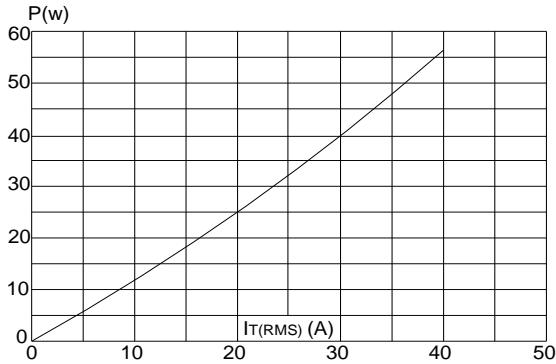

FIG.2: RMS on-state current versus case temperature

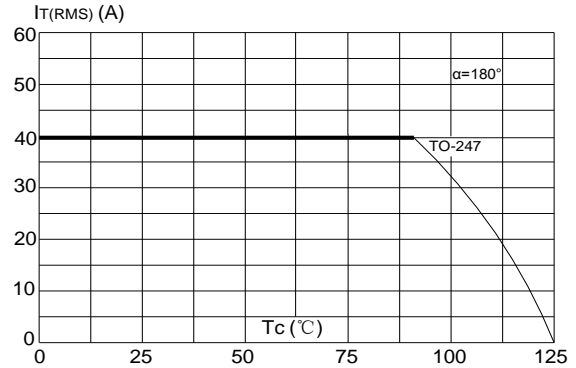

FIG.3: Surge peak on-state current versus number of cycles

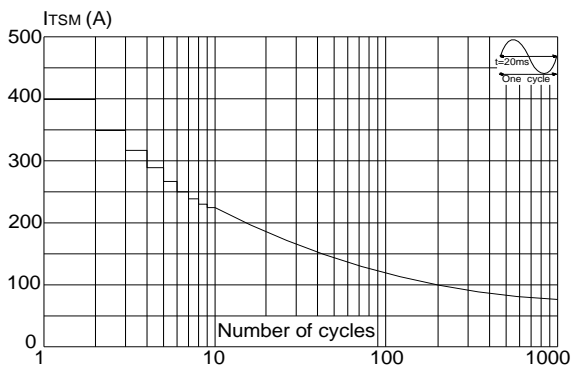

FIG.4: On-state characteristics (maximum values)

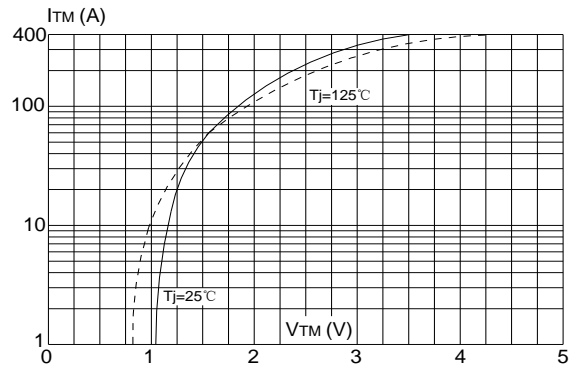

FIG.5: Non-repetitive surge peak on-state current for a sinusoidal pulse with width $t_p < 20\text{ms}$, and corresponding value of I^2t ($di/dt < 50\text{A}/\mu\text{s}$)

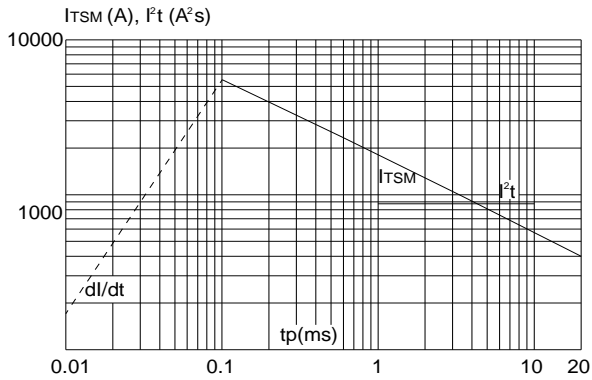
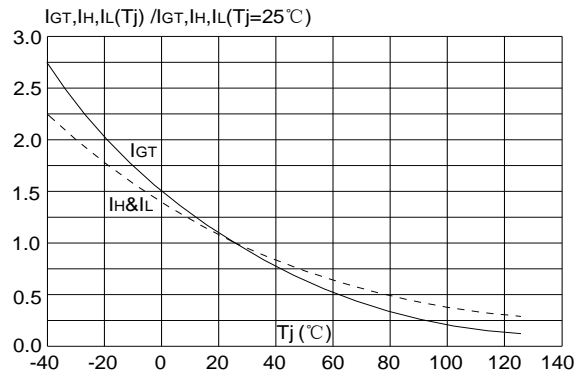
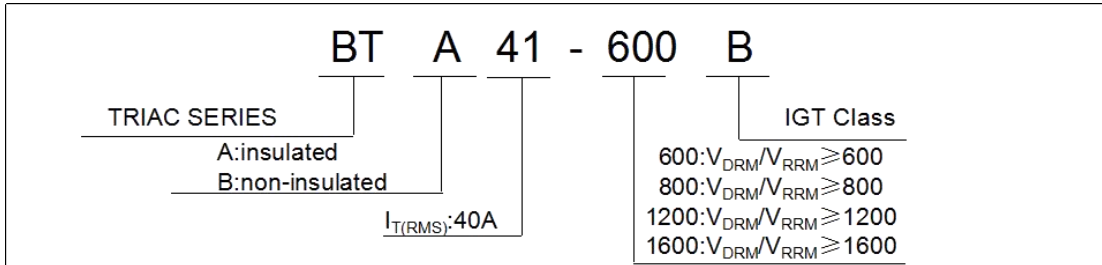

FIG.6: Relative variations of gate trigger current, holding current and latching current versus junction temperature



Ordering Information:



Package Mechanical Data :

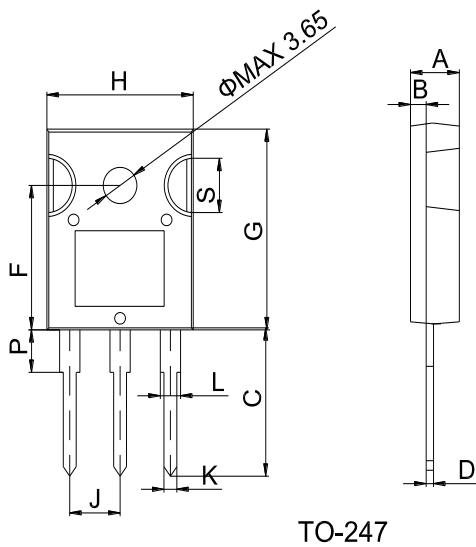

Ref.	Dimensions					
	Millimeters			Inches		
	Min.	Typ.	Max.	Min.	Typ.	Max.
A	4.9		5.4	0.193		0.213
B	1.6		2.0	0.063		0.079
C	14.35		15.4	0.565		0.606
D	0.5		0.8	0.020		0.031
F	14.4		15.1	0.567		0.594
G	19.7		20.6	0.775		0.811
H	15.4		16.2	0.606		0.638
J	5.3		5.6	0.209		0.220
K	1.3		1.5	0.051		0.059
L	2.8		3.3	0.110		0.130
P	3.7		4.2	0.146		0.165
S	5.35		5.65	0.211		0.222