

1200V 80mΩ N-Channel SiC Power MOSFET

Description

The AKCQH080N120B is a high blocking voltage N-Channel SiC power MOSFET. This device provide excellent performance for high voltage power supplies or pulse circuits.

Features

- Typical on-Resistance: $R_{DS(on)}=80m\Omega$ (typ.)
- High Blocking Voltage
- 100% Avalanche Test
- Good Stability and Uniformity with High E_{AS}

Applications

- Solar Inverters
- High Voltage DC/DC Converters
- Motor Drivers
- Switch Mode Power Supplies

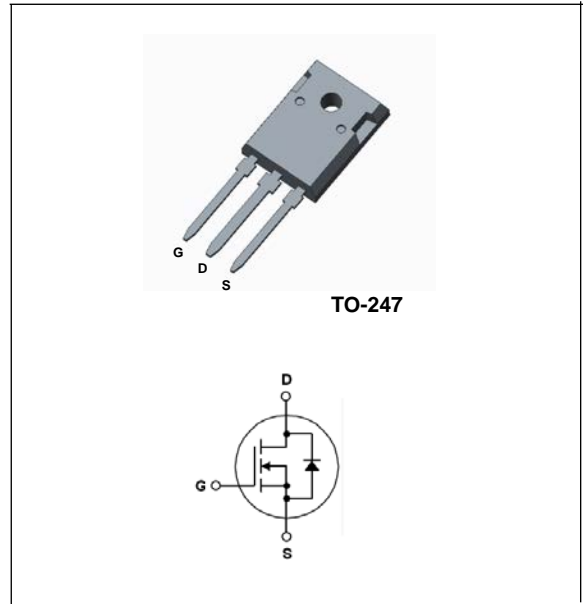

Absolute Maximum Ratings @ $T_C=25\text{ }^\circ\text{C}$ unless otherwise noted

Symbol	Parameter	Ratings	Unit
V_{DSS}	Drain to Source Voltage	1200	V
V_{GSS}	Gate to Source Voltage	-10/+25	V
V_{GSop}	Recommended operation Values of Gate -Source Voltage	-5/+20	V
I_D	Drain Current	$T_C=25\text{ }^\circ\text{C}$	33
		$T_C=100\text{ }^\circ\text{C}$	23.8
I_{DM}	Pulsed Drain Current (Note1)	80	A
P_D	Maximum Power Dissipation	$T_C=25\text{ }^\circ\text{C}$	300
	Derate above 25 $^\circ\text{C}$		2.86
E_{AS}	Single Pulsed Avalanche Energy (Note 2)	800	mJ
T_J	Operating Junction Temperature Range	-40~+175	$^\circ\text{C}$
T_{STG}	Storage Temperature Range	-40~+175	$^\circ\text{C}$

Thermal Characteristics

Symbol	Parameter	Ratings	Unit
$R_{th(J-C)}$	Thermal Resistance, Junction to case	0.5	$^\circ\text{C}/\text{W}$
$R_{th(J-A)}$	Thermal Resistance, Junction to Ambient	40	$^\circ\text{C}/\text{W}$

Electrical Characteristics @ $T_c=25\text{ }^\circ\text{C}$ unless otherwise noted

Symbol	Parameter	Conditions	Min.	Typ.	Max.	Unit
BV_{DSS}	Drain to Source Breakdown Voltage	$V_{GS}=0V, I_D=100\mu A$	1200	-	-	V
$V_{GS(th)}$	Gate Threshold Voltage	$V_{DS}=V_{GS}, I_D=15mA$	2	2.5	4.2	V
$R_{DS(on)}$	Static Drain-Source On-Resistance	$V_{GS}=20V, I_D=20A$	-	75	95	m Ω
I_{DSS}	Zero Gate Voltage Drain Current	$V_{DS}=V_{DSS}, V_{GS}=0V$	-	-	100	μA
I_{GSS}	Gate to Source Leakage Current	$V_{GS}=V_{GSS}, V_{DS}=0V$	-	-	± 500	nA

D-S Diode Characteristics and Maximum Rating @ $T_c=25\text{ }^\circ\text{C}$ unless otherwise noted

Symbol	Parameter	Conditions	Min.	Typ.	Max.	Unit
V_{SD}	Drain-Source Diode Forward Voltage	$V_{GS}=0V, I_S=10A$	-	3.1	-	V
t_{rr}	Reverse Recovery Time	$V_{GS}=0V, I_S=20A,$ $di/dt=-1000A/\mu s$	-	30	-	ns
Q_{rr}	Reverse Recovery Charge		-	70	-	nC

Switching Characteristics @ $T_c=25\text{ }^\circ\text{C}$ unless otherwise noted

Symbol	Parameter	Conditions	Min.	Typ.	Max.	Unit
$t_{d(on)}$	Turn-on Delay Time	$I_D=20A,$ $V_{DD}=800V,$ $R_G=2.5\Omega$ $V_{GS} = -5/20V,$ (Note 3)	-	26	-	ns
t_r	Turn-on Rise Time		-	22	-	ns
$t_{d(off)}$	Turn-off Delay Time		-	50	-	ns
t_f	Turn-off Fall Time		-	39	-	ns
C_{iss}	Input Capacitance	$V_{GS}=0V, V_{DS}=800V,$ $f=1.0MHz$	-	1250	-	pF
C_{oss}	Output Capacitance		-	70	-	pF
C_{riss}	Reverse Transfer Capacitance		-	10.2	-	pF
Q_g	Total Gate Charge	$I_D=20A,$ $V_{DD}=800V$ $V_{GS}=-5V/20V$ (Note 3)	-	75	-	nC
Q_{gs}	Gate to Source Charge		-	25	-	nC
Q_{gd}	Gate to Drain Charge		-	15.8	-	nC

Note:

1. Repetitive rating: pulse-width limited by maximum junction temperature
2. $V_{DD}=100V, L=10mH, V_{clamp}=1200V, V_G=10V$
3. Essentially independent of operating temperature typical characteristics.

Typical Performance Characteristics

Fig. 1. Typical on-Resistance Characteristics

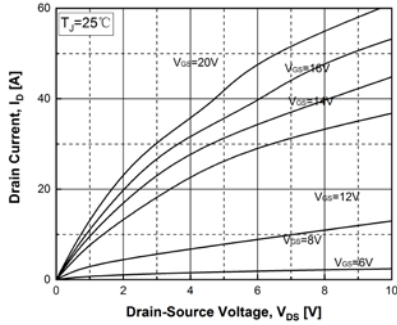

Fig. 2. On-Resistance vs. Drain Current and Gate Voltage

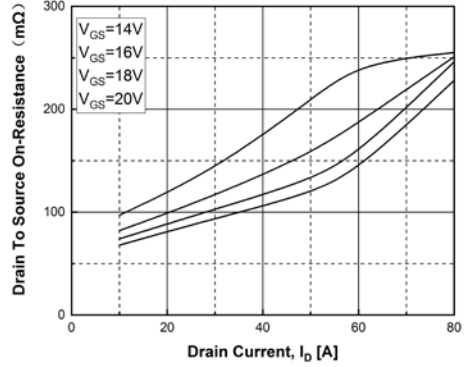

Fig. 3. Normalized On-Resistance vs. Junction Temperature

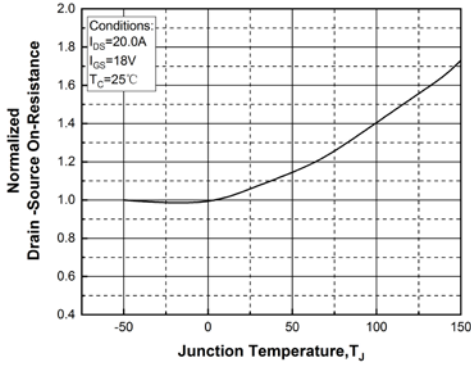

Fig. 4. On-Resistance vs. Gate-to-source Voltage

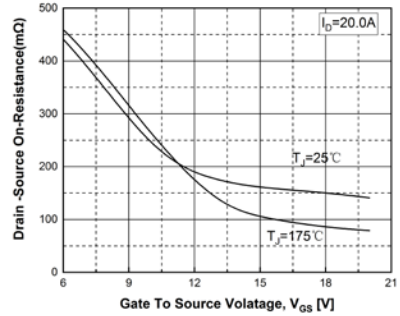

Fig. 5. Transfer Characteristics

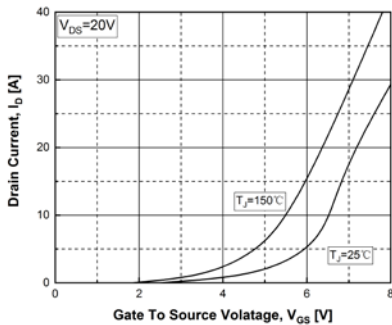
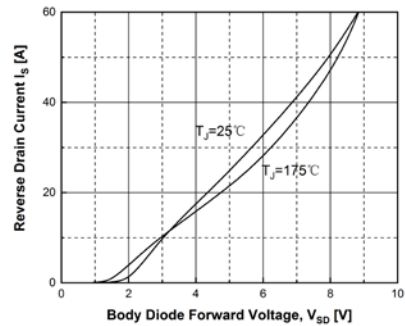

Fig. 6. Source-to-Drain Diode Forward Voltage vs. Source Current



Typical Performance Characteristics

Fig. 7. Gate Charge Characteristics

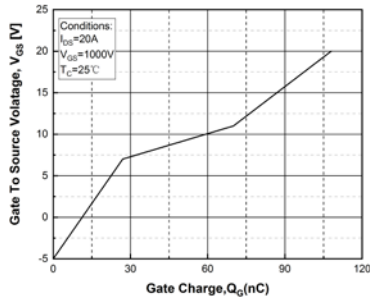

Fig. 8. Characteristics vs. Drain-to-Source Voltage

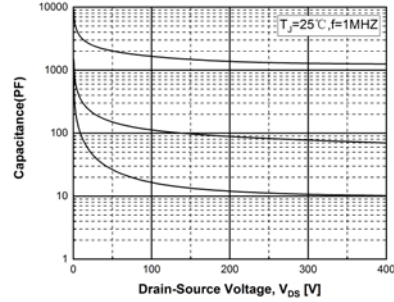
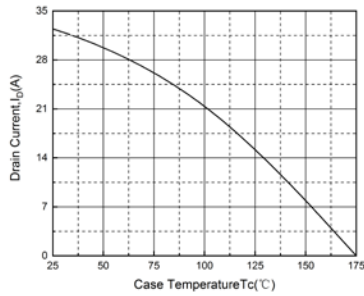

Fig. 9. Maximum Drain Current vs. Temperature



Package Dimensions

TO-247

(Dimensions in Millimeters)

