

650V 65mΩ N-Channel SiC Power MOSFET

Description

The AKCQH065N65L4 is a high blocking voltage N-Channel SiC power MOSFET. This device provide excellent performance for SMPS,UPS, Solar PV inverters , EV charging infrastructure, Energy storage and battery formation.

Features

- Typical on-Resistance: $R_{DS(on)}=65m\Omega$ (typ.)
- High Blocking Voltage
- 100% Avalanche Test
- Good Stability and Uniformity with High E_{AS}

Applications

- SMPS
- UPS
- Solar PV inverters
- EV charging infrastructure
- Energy storage and battery formation

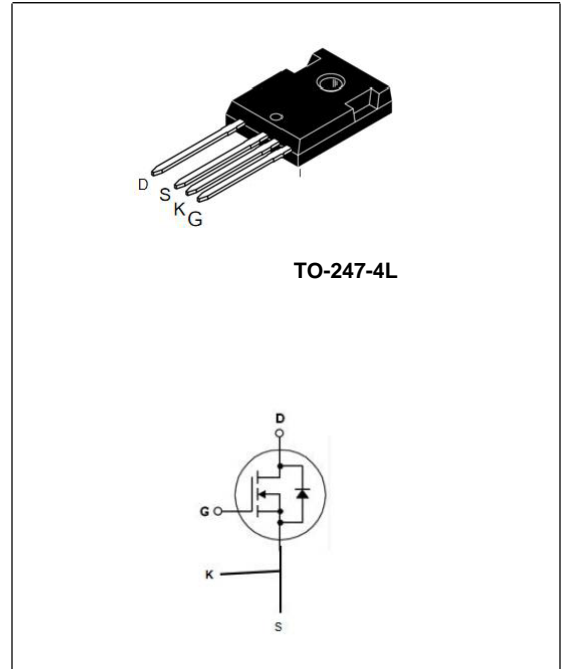

Absolute Maximum Ratings @ $T_C=25\text{ }^\circ\text{C}$ unless otherwise noted

Symbol	Parameter	Ratings	Unit
V_{DSS}	Drain to Source Voltage	650	V
V_{GSS}	Gate to Source Voltage	-8/+22	V
V_{GSop}	Recommended operation Values of Gate -Source Voltage	-4/+18	V
I_D	Drain Current	$T_C=25\text{ }^\circ\text{C}$	29
		$T_C=100\text{ }^\circ\text{C}$	18
I_{DM}	Pulsed Drain Current (Note1)	99	A
P_D	Maximum Power Dissipation	$T_C=25\text{ }^\circ\text{C}$	428
	Derate above $25\text{ }^\circ\text{C}$		2.86
E_{AS}	Single Pulsed Avalanche Energy (Note 2)	102	mJ
T_J	Operating Junction Temperature Range	-55~+175	$^\circ\text{C}$
T_{STG}	Storage Temperature Range	-55~+175	$^\circ\text{C}$

Thermal Characteristics

Symbol	Parameter	Ratings	Unit
$R_{th(J-C)}$	Thermal Resistance, Junction to case	0.35	$^\circ\text{C}/\text{W}$
$R_{th(J-A)}$	Thermal Resistance, Junction to Ambient	40	$^\circ\text{C}/\text{W}$

Electrical Characteristics @T_C=25 °C unless otherwise noted

Symbol	Parameter	Conditions	Min.	Typ.	Max.	Unit
BV _{DSS}	Drain to Source Breakdown Voltage	V _{GS} =0V, I _D =100uA	650	-	-	V
V _{GS(th)}	Gate Threshold Voltage	V _{DS} =V _{GS} , I _D =5mA	1.8	3.0	4	V
R _{DS(on)}	Static Drain-Source On-Resistance	V _{GS} =18V, I _D =20A	-	65	80	mΩ
I _{DSS}	Zero Gate Voltage Drain Current	V _{DS} =V _{DSS} , V _{GS} =0V	-	-	100	uA
I _{GSS}	Gate to Source Leakage Current	V _{GS} =V _{GSS} , V _{DS} =0V	-	-	±500	nA

D-S Diode Characteristics and Maximum Rating @T_C=25 °C unless otherwise noted

Symbol	Parameter	Conditions	Min.	Typ.	Max.	Unit
V _{SD}	Drain-Source Diode Forward Voltage	V _{GS} =0V, I _S =6.6A	-	4.4	-	V
t _{rr}	Reverse Recovery Time	V _{GS} =0V, I _S =14.5A, V _{DD} =400V	-	30	-	ns
Q _{rr}	Reverse Recovery Charge		-	50	-	nC

Switching Characteristics @T_C=25 °C unless otherwise noted

Symbol	Parameter	Conditions	Min.	Typ.	Max.	Unit
t _{d(on)}	Turn-on Delay Time	I _D =20A , V _{DD} =400V, R _G =2.0Ω V _{GS} = -5/20V, (Note 3)	-	16.0	-	ns
t _r	Turn-on Rise Time		-	9.0	-	ns
t _{d(off)}	Turn-off Delay Time		-	20.2	-	ns
t _f	Turn-off Fall Time		-	6.1	-	ns
C _{iss}	Input Capacitance	V _{GS} =0V, V _{DS} =400V, f=1.0MHz	-	830	-	pF
C _{oss}	Output Capacitance		-	82	-	pF
C _{rss}	Reverse Transfer Capacitance		-	14	-	pF
Q _g	Total Gate Charge	I _D =14.5A, V _{DD} =400V V _{GS} =-4V/18V (Note 3)	-	50	-	nC
Q _{gs}	Gate to Source Charge		-	13	-	nC
Q _{gd}	Gate to Drain Charge		-	12	-	nC

Note:

1. Repetitive rating: pulse-width limited by maximum junction temperature
2. V_{DD}=50V, L=10mH, V_{clamp}=650V, V_G=10V, I_D=4.5A
3. Essentially independent of operating temperature typical characteristics

Typical Performance Characteristics

Fig. 1. Typical on-Resistance Characteristics

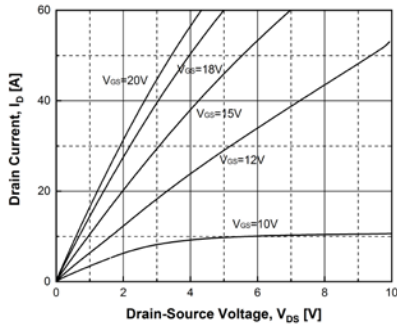

Fig. 2. Normalized On-Resistance vs. Drain Current and Gate Voltage

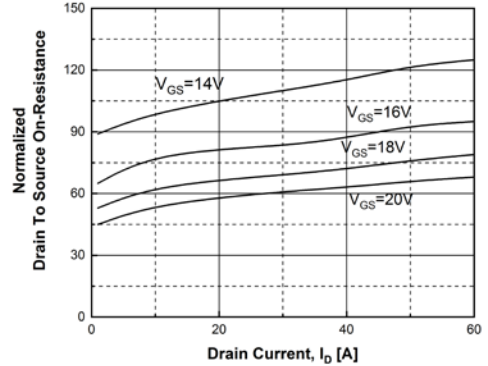

Fig. 3. Normalized On-Resistance vs. Junction Temperature

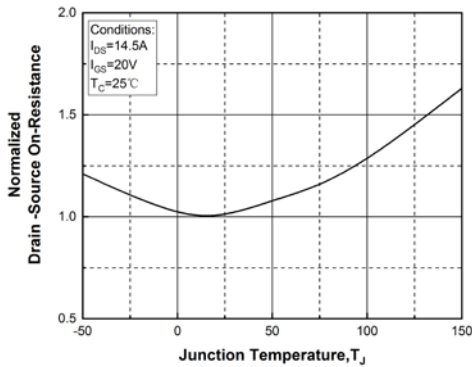

Fig. 4. On-Resistance vs. Gate-to-source Voltage

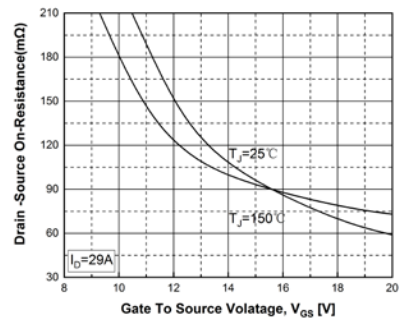

Fig. 5. Transfer Characteristics

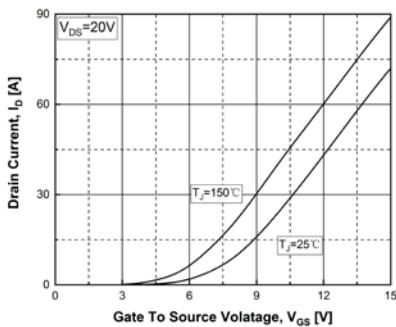
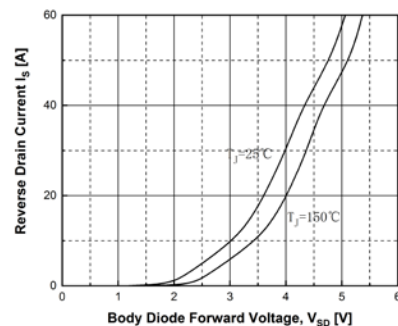

Fig. 6. Source-to-Drain Diode Forward Voltage vs. Source Current



Typical Performance Characteristics

Fig. 7. Gate Charge Characteristics

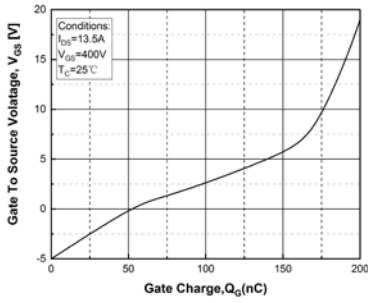

Fig. 8. Characteristics vs. Drain-to-Source Voltage

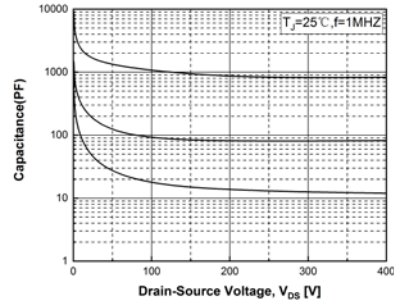
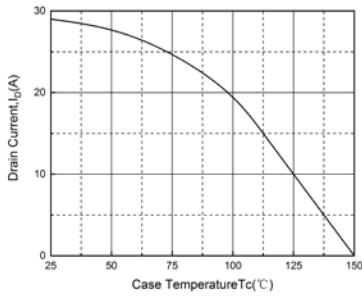

Fig. 9. Maximum Drain Current vs. Temperature



Package Dimensions

TO-247-4L

(Dimensions in Millimeters)

