

900V 4A N-Channel Enhancement Mode Power MOSFET

Description

The AKQB4N90C2 is an N-Channel on-resistance and high avalanche energy enhancement mode power MOSFET which using proprietary planar stripe and DMOS technology. This MOSFET has low static strength. This device provide excellent switching performance for switched mode power supplies, active power factor correction and electronic lamp ballasts.

Features

- Low on-Resistance: $R_{DS(on)}=2.3\Omega(\text{typ.})$
- Special Process Technology for high ESD Capability
- 100% Avalanche Test
- Good Stability and Uniformity with High E_{AS}

Applications

- Switched Mode Power Supplies
- Active Power Factor Correction, Electronic Ballasts

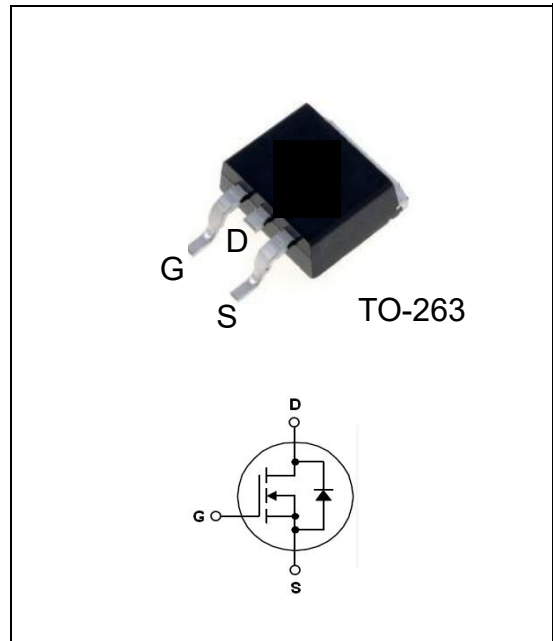

Absolute Maximum Ratings @ $T_c=25^\circ\text{C}$ unless otherwise noted

Symbol	Parameter	Ratings	Unit
V_{DSS}	Drain to Source Voltage	900	V
V_{GSS}	Gate to Source Voltage	± 30	V
I_D	Drain Current	$T_c=25^\circ\text{C}$	4
		$T_c=100^\circ\text{C}$	2.3
I_{DM}	Pulsed Drain Current (Note1)	16	A
P_D	Maximum Power Dissipation	$T_c=25^\circ\text{C}$	138
	Derate above 25°C		1.11
E_{AS}	Single Pulsed Avalanche Energy (Note 2)	900	mJ
T_J	Operating Junction Temperature Range	-55~+150	$^\circ\text{C}$
T_{STG}	Storage Temperature Range	-55~+150	$^\circ\text{C}$

Thermal Characteristics

Symbol	Parameter	Ratings	Unit
$R_{th(J-C)}$	Thermal Resistance, Junction to case	0.9	$^\circ\text{C/W}$
$R_{th(J-A)}$	Thermal Resistance, Junction to Ambient	63	$^\circ\text{C/W}$

Electrical Characteristics @ $T_c=25\text{ }^\circ\text{C}$ unless otherwise noted

Symbol	Parameter	Conditions	Min.	Typ.	Max.	Unit
BV_{DSS}	Drain to Source Breakdown Voltage	$V_{GS}=0V, I_D=250\mu A$	900	-	-	V
$V_{GS(th)}$	Gate Threshold Voltage	$V_{DS}=V_{GS}, I_D=250\mu A$	3.0	-	5.0	V
$R_{DS(on)}$	Static Drain-Source On-Resistance	$V_{GS}=10V, I_D=2A$	-	2.3	3.0	Ω
I_{DSS}	Zero Gate Voltage Drain Current	$V_{DS}=V_{DSS}, V_{GS}=0V$	-	-	10	μA
I_{GSS}	Gate to Source Leakage Current	$V_{GS}=V_{GSS}, V_{DS}=0V$	-	-	± 100	nA

D-S Diode Characteristics and Maximum Rating @ $T_c=25\text{ }^\circ\text{C}$ unless otherwise noted

Symbol	Parameter	Conditions	Min.	Typ.	Max.	Unit
I_S	Maximum Drain to Source Diode Forward Current		-	-	4.0	A
V_{SD}	Drain-Source Diode Forward Voltage	$V_{GS}=0V, I_S=4A$	-	-	0.84	V
T_{rr}	Reverse Recovery Time	$V_{GS}=0V, I_S=4A,$	-	400	-	ns
Q_{rr}	Reverse Recovery Charge	$di/dt=-100A/\mu s$	-	3.4	-	nC

Switching Characteristics @ $T_c=25\text{ }^\circ\text{C}$ unless otherwise noted

Symbol	Parameter	Conditions	Min.	Typ.	Max.	Unit
$t_{d(on)}$	Turn-on Delay Time	$I_D=4A,$ $V_{DD}=450V,$ $R_G=25\Omega$ (Note 3)	-	35	-	ns
t_r	Rise Time		-	45	-	ns
$t_{d(off)}$	Turn-off Delay Time		-	46	-	ns
t_f	Fall Time		-	42	-	ns
C_{iss}	Input Capacitance	$V_{GS}=0V, V_{DS}=25V,$ $f=1.0MHz$	-	820	-	pF
C_{oss}	Output Capacitance		-	72	-	pF
C_{rss}	Reverse Transfer Capacitance		-	5.9	-	pF
Q_g	Total Gate Charge	$I_D=4A,$ $V_{DD}=720V$ $V_{GS}=10V$ (Note 3)	-	19	-	nC
Q_{gs}	Gate to Source Charge		-	4.8	-	nC
Q_{gd}	Gate to Drain Charge		-	8.1	-	nC

Note:

1. Repetitive rating: pulse-width limited by maximum junction temperature
2. $V_{DD}=100V, L=5mH, R_G=25\Omega, V_G=10V,$ stating $T_j=25^\circ\text{C}$
3. Essentially independent of operating temperature typical characteristics

Typical Performance Characteristics

Fig. 1. Typical on-Region Characteristics

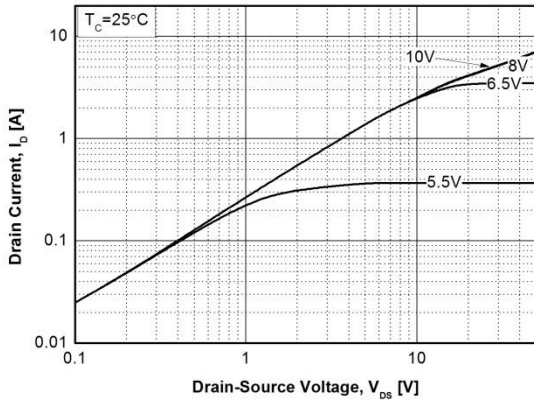

Fig. 2. Typical Transfer Characteristics

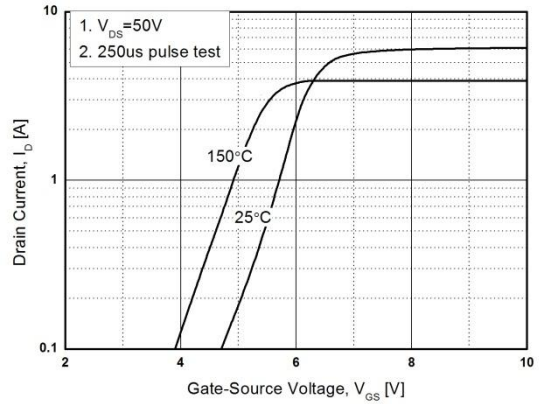

Fig. 3. Static on-Resistance vs. I_D

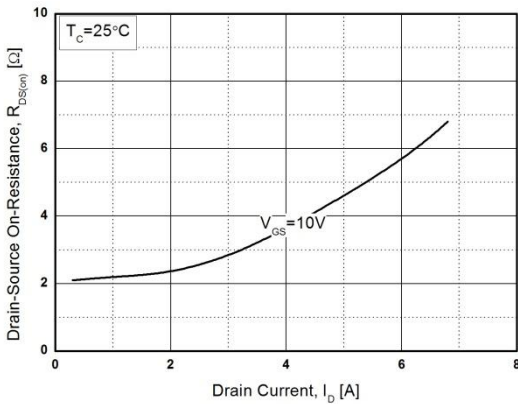

Fig. 4. Body Diode Forward Voltage vs. I_{DR}

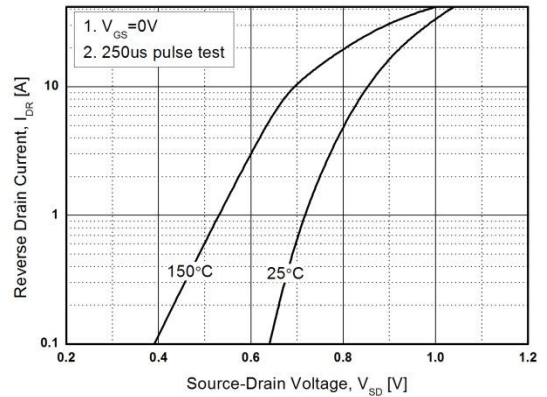

Fig. 5. Capacitance Characteristics

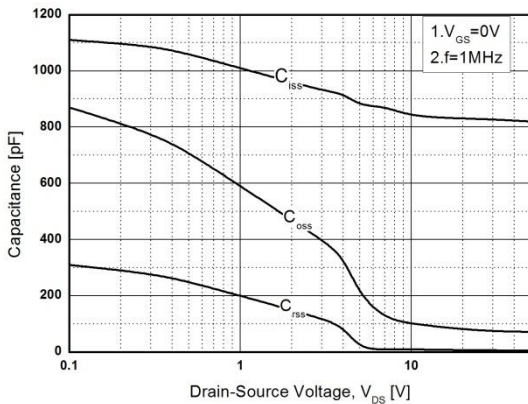
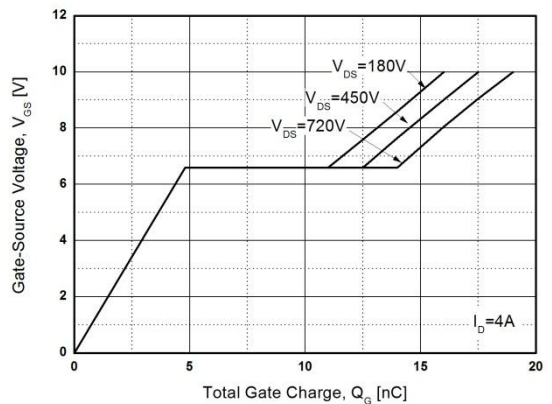

Fig. 6. Gate Charge Characteristics



Typical Performance Characteristics

Fig. 7. Breakdown Voltage vs. Temperature

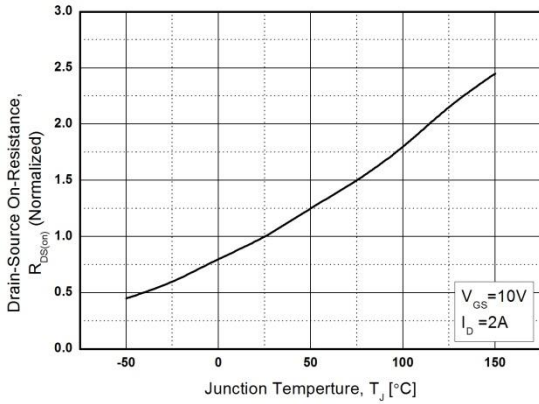

Fig. 8. Static on-Resistance vs. Temperature

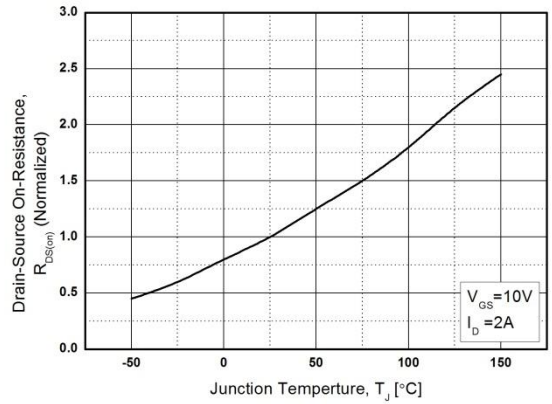

Fig. 9. Maximum Safe Operating Area

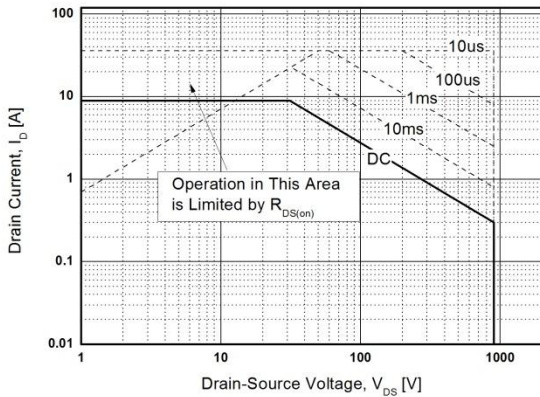

Fig. 10. Maximum Drain Current vs. Temperature

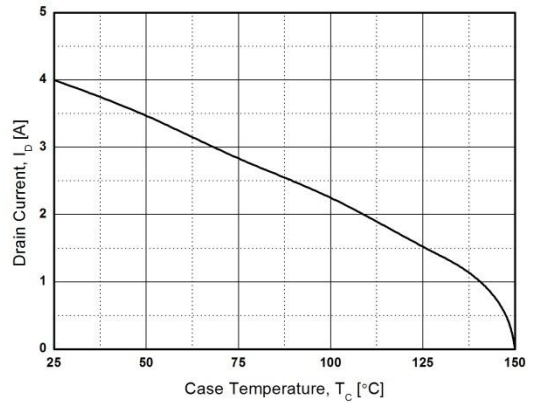
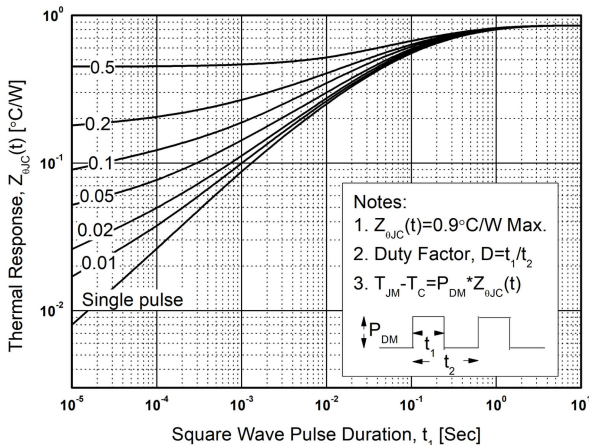

Fig. 11. Transient Thermal Response Curve



Package Dimensions

TO-263

(Dimensions in Millimeters)

