

## 80V 200A N-Channel Trench MOSFET

### Description

The AKQP200N08 is an N-Channel enhancement mode power MOSFET and based on advanced trench technology, it has extremely low static on-resistance and high avalanche energy strength. This device provide excellent switching performance for switched mode power supplies.

### Features

- Advanced Trench Technology
- Typical on-Resistance:  
 $R_{DS(on)}=3.1m\Omega @V_{GS}=10V, I_D=100A$
- Rated Avalanche Energy
- RoHS Compliant

### Applications

- Switched Mode Power Supplies
- Motor Control
- Synchronous Rectification

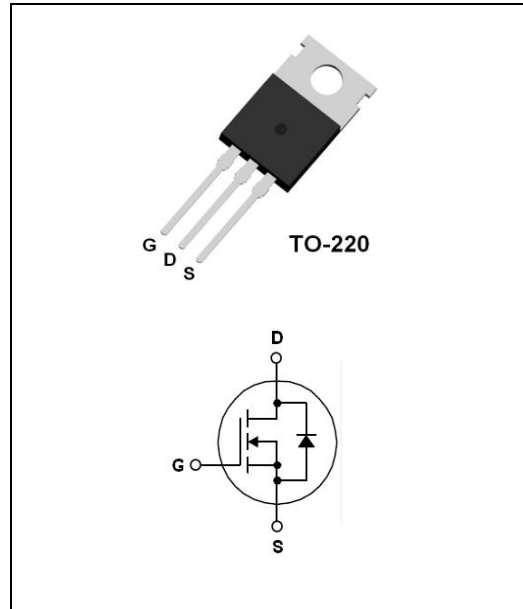

### Absolute Maximum Ratings @ $T_C=25^\circ C$ unless otherwise noted

Symbol	Parameter	Ratings	Unit	
$V_{DSS}$	Drain to Source Voltage	80	V	
$V_{GSS}$	Gate to Source Voltage	$\pm 25$	V	
$I_D$	Drain Current	$T_C=25^\circ C$	200	A
		$T_C=100^\circ C$	126	A
$I_{DM}$	Pulsed Drain Current (Note1)	800	A	
$P_D$	Maximum Power Dissipation	$T_C=25^\circ C$	220	W
	Derate above $25^\circ C$		1.67	W/ $^\circ C$
$E_{AS}$	Single Pulsed Avalanche Energy (Note 2)	625	mJ	
$T_J$	Operating Junction Temperature Range	-55~+150	$^\circ C$	
$T_{STG}$	Storage Temperature Range	-55~+150	$^\circ C$	

### Thermal Characteristics

Symbol	Parameter	Ratings	Unit
$R_{th(J-C)}$	Thermal Resistance, Junction to case	0.6	$^\circ C/W$
$R_{th(J-A)}$	Thermal Resistance, Junction to Ambient	45	$^\circ C/W$

## Electrical Characteristics @ $T_c=25\text{ }^\circ\text{C}$ unless otherwise noted

Symbol	Parameter	Conditions	Min.	Typ.	Max.	Unit
$BV_{DSS}$	Drain to Source Breakdown Voltage	$V_{GS}=0V, I_D=250\mu A$	80	-	-	V
$V_{GS(th)}$	Gate Threshold Voltage	$V_{DS}=V_{GS}, I_D=250\mu A$	2	-	4	V
$R_{DS(on)}$	Static Drain-Source On-Resistance	$V_{GS}=10V, I_D=100A$	-	3.1	7.0	m $\Omega$
$I_{DSS}$	Zero Gate Voltage Drain Current	$V_{DS}=V_{DSS}, V_{GS}=0V$	-	-	10	$\mu A$
$I_{GSS}$	Gate to Source Leakage Current	$V_{GS}=V_{GSS}, V_{DS}=0V$	-	-	$\pm 100$	nA

## D-S Diode Characteristics and Maximum Rating @ $T_c=25\text{ }^\circ\text{C}$ unless otherwise noted

Symbol	Parameter	Conditions	Min.	Typ.	Max.	Unit
$I_S$	Maximum Drain to Source Diode Forward Current		-	-	200	A
$V_{SD}$	Drain-Source Diode Forward Voltage	$V_{GS}=0V, I_S=200A$	-	0.95	1.2	V
$t_{rr}$	Reverse Recovery Time	$V_{GS}=0V, I_S=100A,$	-	95	-	ns
$Q_{rr}$	Reverse Recovery Charge	$di/dt=-100A/\mu s$	-	225	-	nC

## Switching Characteristics @ $T_c=25\text{ }^\circ\text{C}$ unless otherwise noted

Symbol	Parameter	Conditions	Min.	Typ.	Max.	Unit
$t_{d(on)}$	Turn-on Delay Time	$I_D=100A,$ $V_{DD}=40V, V_{GS}=10V$ $R_G=10\Omega$ (Note 3)	-	30.5	-	ns
$t_r$	Rising Time		-	29	-	ns
$t_{d(off)}$	Turn-off Delay Time		-	95	-	ns
$t_f$	Falling Time		-	34.5	-	ns
$C_{iss}$	Input Capacitance	$V_{GS}=0V, V_{DS}=40V,$ $f=1.0MHz$	-	8500	-	pF
$C_{oss}$	Output Capacitance		-	1520	-	pF
$C_{riss}$	Reverse Transfer Capacitance		-	81	-	pF
$Q_g$	Total Gate Charge	$I_D=100A,$ $V_{DD}=40V$ $V_{GS}=10V$ (Note 3)	-	105	-	nC
$Q_{gs}$	Gate to Source Charge		-	39	-	nC
$Q_{gd}$	Gate to Drain Charge		-	28	-	nC

### Note:

1. Repetitive rating: pulse-width limited by maximum junction temperature
2.  $V_{DD}=50V, L=500\mu H, V_G=10V, I_{AS}=50A$
3. Essentially independent of operating temperature typical characteristics

**Typical Performance Characteristics**

Fig. 1. Typical on-Resistance Characteristics

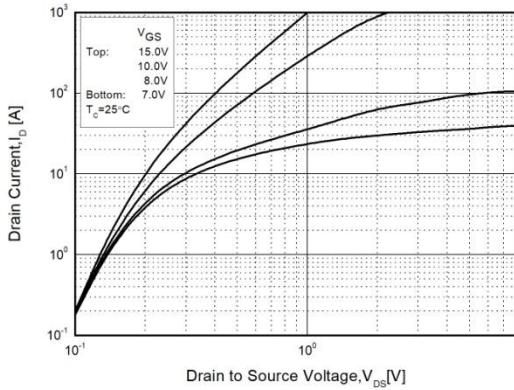

Fig. 2. Typical Transfer Characteristics

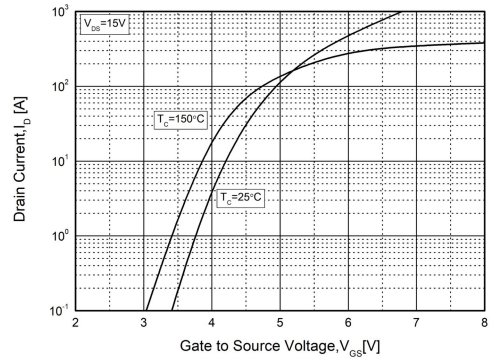

Fig. 3. Static on-Resistance vs.  $I_D$

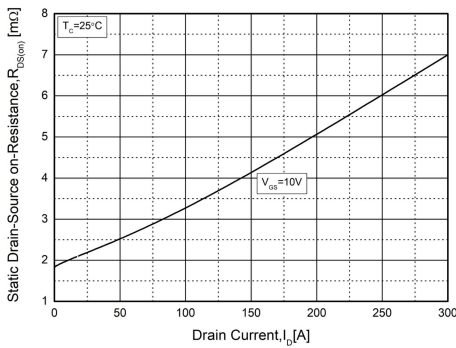

Fig. 4. Body Diode Forward Voltage vs.  $I_{DR}$

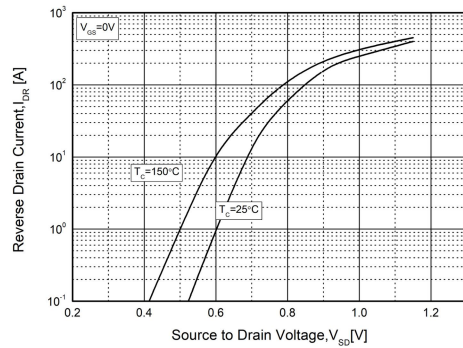

Fig. 5. Capacitance Characteristics

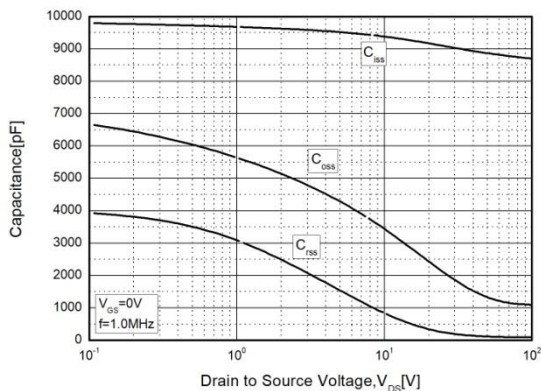
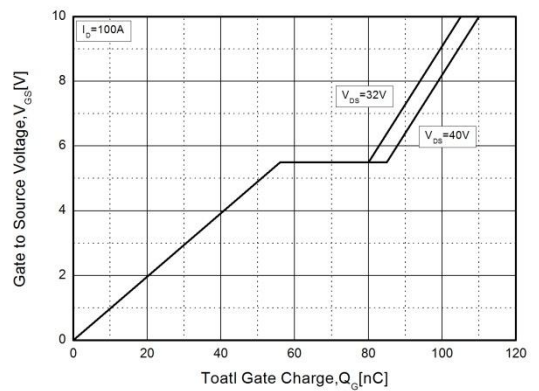

Fig. 6. Gate Charge Characteristics



**Typical Performance Characteristics**

Fig. 7. Breakdown Voltage vs. Temperature

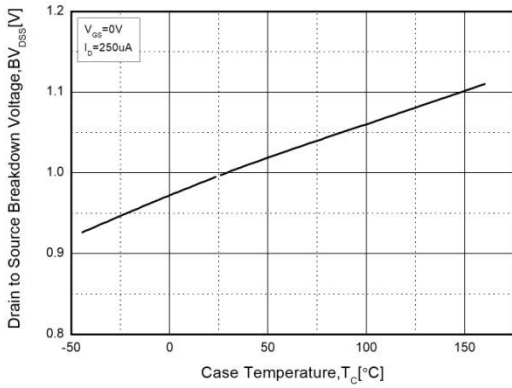

Fig. 8. Static on-Resistance vs. Temperature

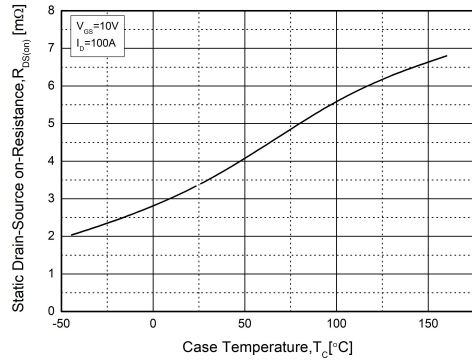

Fig. 9. Maximum Safe Operating Area

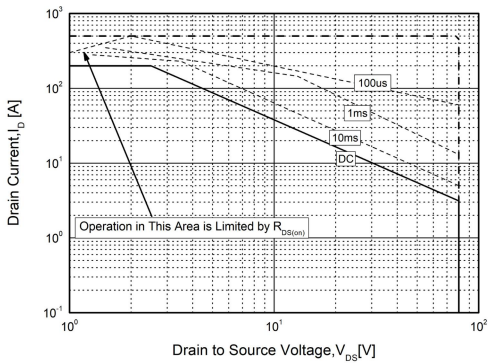

Fig. 10. Maximum Drain Current vs. Temperature

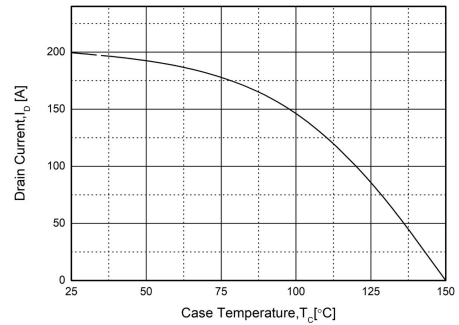
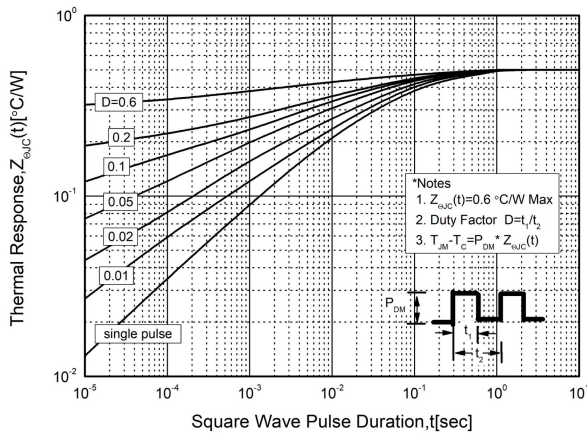

Fig. 11. Transient Thermal Response Curve



Package Dimensions

TO-220

(Dimensions in Millimeters)

